

***LASER TECHNOLOGY, INC.***



***TRUPULSE™ 360 / 360B***

***USER'S MANUAL 2<sup>ND</sup> EDITION***

LTI TruPulse 360 / 360B  
User's Manual Second Edition  
Part Number 0144801

**Copyright Notice:**

Information in this document is subject to change without notice and does not represent a commitment on the part of Laser Technology Inc. No part of this manual may be reproduced in any form or by any means, electronic or mechanical, including photocopying, recording, or information storage and retrieval systems, for any purpose other than the purchaser's personal use, without the express written consent of Laser Technology, Inc.

Copyright © Laser Technology, Inc., 2007 - 2009. All rights reserved.  
First Edition: September 2007  
Second Edition: January 2009

**Patents:**

This product is covered by pending patent applications and/or the following issued U.S. Patents:  
6,445,444, 5,612,779, 6,057,910, 6,226,077.

**Trademarks:**

Criterion, Impulse, and TruPulse are trademarks of Laser Technology, Inc. The Bluetooth trademarks are owned by Bluetooth SIG, Inc. All other trademarks are the property of their respective owners.

**LTI Contact Information:**

Laser Technology, Inc.  
7070 S. Tucson Way  
Centennial, CO 80112-3921 USA  
Phone: 1-303-649-1000  
1-877-696-2584 (USA and Canada)  
Fax: 1-303-649-9710  
Web Site: www.lasertech.com  
Email: service@lasertech.com

TruPulse Reference Information: Record information about your TruPulse in the table below.

	<i>You can find this value:</i>	<i>Your TruPulse</i>
Serial Number	On the serial number sticker affixed to the TruPulse.	
Firmware Revision Numbers	See <a href="#">page 15</a> for information.	Main:  Auxiliary:

# Table of Contents

<b>Precautions</b> .....	<b>3</b>
<b>Section 1 - Introducing the LTI TruPulse 360</b> .....	<b>4</b>
Operating Modes.....	4
Unpacking Your TruPulse.....	5
Basic Package.....	5
Compatible Accessories.....	5
Understanding How the TruPulse Works.....	5
LCD Display.....	5
Laser Range Sensor.....	5
TruTargeting.....	6
Tilt Sensor.....	6
Compass.....	7
TruVector™ Technology.....	7
Digital Processor.....	7
<b>Section 2 - Quick Start</b> .....	<b>8</b>
<b>Section 3 - Basic Operations</b> .....	<b>9</b>
Batteries.....	9
Installation.....	9
Low Battery Warning.....	9
Buttons.....	10
Powering OFF the TruPulse.....	11
Display Indicators.....	11
Display Indicator Test.....	14
Eyepiece.....	14
Diopter Adjustment Ring.....	15
Firmware Revision Numbers.....	15
Measuring Point.....	15
Neck Strap.....	16
Restore Default Settings.....	16
<b>Section 4 - System Setup</b> .....	<b>17</b>
Select Measurement Units.....	18
Enable Bluetooth.....	19
Align the Tilt Sensor.....	21
Tilt Sensor Calibration Routine.....	22
Horizontal Angle Menu.....	24
Declination Menu.....	24

About Magnetic Declination .....	25
Example Declination Value .....	26
Online Declination Software .....	26
Entering a Declination Value .....	27
Local Magnetic Attractions .....	27
Field Tests for Local Magnetic Conditions .....	28
Horizontal Angle Compass Calibration Menu .....	29
Horizontal Angle Compass Calibration Routine .....	30
<b>Section 5 - Measurement Modes .....</b>	<b>32</b>
Distance Measurements .....	32
Notes about Measurements .....	33
Inclination Measurements .....	33
Percent Slope .....	33
Azimuth Measurements .....	34
Height Routine .....	34
Missing Line Routine .....	36
Improving the Accuracy of Handheld Results .....	38
<b>Section 6 - Target Modes .....</b>	<b>39</b>
<b>Section 7 - Care &amp; Maintenance .....</b>	<b>40</b>
<b>Section 8 - Serial Data Interface .....</b>	<b>41</b>
Format Parameters .....	41
Serial Port .....	41
Download Instructions .....	41
Optional Remote Trigger .....	42
Download Message Format .....	42
Query .....	42
Download Message Formats .....	44
Horizontal Vector (HV) Download Messages .....	44
Height (HT) Download Messages .....	45
Missing Line (ML) Download Messages .....	46
Uploading Serial Data .....	47
Upload Serial Data Commands .....	47
<b>Section 9 - Specifications .....</b>	<b>49</b>
<b>Section 10 – LTI Limited Warranty .....</b>	<b>51</b>
<b>Section 11 - Troubleshooting .....</b>	<b>53</b>
<b>Section 12 – Main Display LCD Characters .....</b>	<b>55</b>

## Precautions

### Avoid staring directly at the laser beam for prolonged periods.

The TruPulse™ meets FDA eye safety requirements and is classified as eye-safe to Class 1 limits, which means that virtually no hazard is associated with directly viewing the laser output under normal conditions. As with any laser device, however, reasonable precautions should be taken in its operation. It is recommended that you avoid staring into the transmit aperture while firing the laser. The use of optical instruments with this product may increase eye hazard.

### Never attempt to view the sun through the scope.

Looking at sun through the scope may permanently damage your eyes.

### Never point the unit directly at the sun.

Exposing the lens system to direct sunlight, even for a brief period, may permanently damage the internal components.

### Avoid direct sun exposure on the eyepiece.

Exposing the eyepiece to direct sunlight can damage the internal display.  
The eyepiece cover should be in place whenever the TruPulse is not in use.

### Do not expose the instrument to extreme temperatures.

TruPulse™ components are rated for a temperature range of -4° F to +140° F (-20° C to +60° C). Do not expose the instrument to temperatures outside this range whether in use or in storage.

### CALIBRATE THE TRUPULSE 360 / 360B BEFORE USE.

When you first receive your TruPulse, first complete a Tilt Calibration ([page 21](#)) and then a Horizontal Angle Compass Calibration ([page 29](#)).

For optimum performance, complete an on-site Horizontal Angle Compass Calibration each time that you change location or accessories.

### KEEP THE TRUPULSE 360 / 360B AWAY FROM MAGNETIC FIELDS.

The Compass is susceptible to magnetic interference. Keep away from all ferro-magnetic materials and strong magnetic fields.

## Section 1 - Introducing the LTI TruPulse 360

Congratulations on the purchase of your TruPulse, a cost-effective professional rangefinder. This compact and lightweight laser is a flexible tool for your measurement needs. The TruPulse 360/360B includes seven measurement modes, five target modes, and serial data output.

Features of the TruPulse:

- Crystal clear optics and the heads up display lets you keep your eye on the target.
- "Thru-the-lens" viewing eliminates parallax issues so you know the laser energy is traveling directly along your line of sight.
- The laser sensor, integrated tilt sensor and compass measure slope distance, horizontal distance, vertical distance, inclination (or percent slope), azimuth, or instantly calculate the height of any object or the missing line between two points remote from your position.
- The Target Mode allows you to select or eliminate targets; which helps you take the most accurate measurement possible in a variety of field conditions.
- Adjustable eyepiece provides comfortable viewing for eye or sunglasses wearers.
- Measurement data is available for download to remote PC or Pocket PC. Data communication via wired RS232 serial (standard) or go wireless with the Bluetooth option, TruPulse 360B.

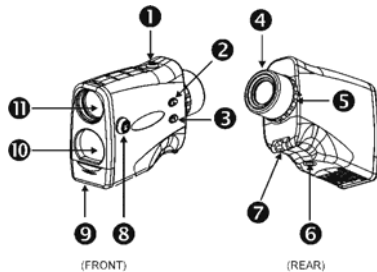

1. FIRE button (power ON)
2. ▲ (UP) button
3. ▼ (DOWN) button
4. Adjustable Eyepiece
5. Diopter Adjustment Ring
6. Tripod / Monopod mount
7. Attachment Point  
(for neck strap and eyepiece cover)
8. RS232 Data Port
9. Battery Compartment Cover
10. Receive Lens
11. Transmit Lens / Viewing Objective

Figure #1

### Operating Modes

#### Measurement Modes

- Slope Distance
- Vertical Distance
- Horizontal Distance
- Inclination (or Percent Slope)
- Azimuth
- 3-Point Height Routine
- Missing Line Routine

#### Target Modes

- Standard
  - Continuous\*\*
  - Closest\*\*
  - Farthest\*\*
  - Filter\*\*
- (\*\*Advanced Targeting Modes)

#### System Setup Modes

- Units Selection
- Bluetooth Enable (360B only)
- Tilt Sensor Calibration
- Horizontal Angle (HA) Menu
- Declination Menu
- HA Compass Calibration Menu

## **Unpacking Your TruPulse**

When you unpack your TruPulse, check to make sure that you received everything that you ordered, and that it all arrived undamaged.

### **Basic Package**

- TruPulse 360 or TruPulse 360B (integrated Bluetooth®)
- Carrying Case
- Eyepiece Cover
- Lens Cloth
- Neck Strap
- User's Manual

### **Compatible Accessories**

- Data Download Cable
- Foliage Filter
- Tripod / Monopod



To learn more about any of the items listed above, please contact your LTI Sales Representative or an Authorized LTI Distributor.

## **Understanding How the TruPulse Works**

The TruPulse consists of a laser range sensor, an integrated tilt sensor, compass and a digital processor. The TruPulse has three buttons that access the unit's internal software, which controls the integrated sensors.

### **LCD Display**

A liquid crystal display (LCD) is mounted within the optical system and when activated, displays a reticle for targeting, yards / meters, and the display indicators. Inherent in the manufacturing process are small black spots that appear in the optical system. These are a natural characteristic of the LCD and cannot be fully eliminated in the manufacturing process. These small black spots do not affect the distancing performance of the unit.

### **Laser Range Sensor**

The laser range sensor emits invisible, eye safe, infrared energy pulses. The TruPulse determines distance by measuring the time it takes for each pulse to travel from the rangefinder to the target, and back. The LASER indicator is displayed whenever the laser is being transmitted. The laser may be active for a maximum of 10 seconds. Once the target is acquired or the laser has timed out, you can release the FIRE button. The TruPulse has a broad spectrum of sensitivity and can work with both reflective and non-reflective targets. See TruTargeting (next page) for information about high quality and low quality targets.

## TruTargeting

The TruPulse automatically provides the best accuracy and acquisition distance to a given target. Maximum measurement distance varies with target quality and environmental conditions. When shooting to a non-reflective target, the maximum measurement distance is approximately 1,000 meters (3,280 feet). When shooting to a reflective target, the maximum measurement distance is approximately 2,000 meters (6,560 feet).

When selecting a target, you should consider the following:

- *Color:* The brighter the color, the longer the range.
- *Finish:* Shiny finishes provide longer range than dull finishes.
- *Angle:* Shooting perpendicular to a target provides better range than shooting to a target at a sharp angle.
- *Lighting Conditions:* Overcast skies increase the unit's maximum range, and sunny skies decrease the unit's maximum range.

Target quality has an effect on the precision of measurements. A high quality target will result in a measurement that includes one decimal place (tenths). A low quality target will result in a measurement that is a whole number.





Examples:

- 120 feet (meters / yards) indicates a measurement was made to a low quality target.
  - Accuracy:  $\pm 1$  yd ( $\pm 1$  m).
- 120.0 feet (meters / yards) indicates a measurement was made to a high quality target.
  - Feet are shown in half-unit increments (.0 or .5).
  - Meters and Yards are shown in tenth-unit increments (.0 - .9).
  - Accuracy:  $\pm 1$  foot ( $\pm 30$  cm).

## Tilt Sensor

The integrated tilt sensor measures vertical angles that the TruPulse uses to calculate height and elevation and to determine slope-reduced horizontal distances. The instrument held level is at  $0^\circ$ , and is rotated up through  $+90^\circ$ , and down through  $-90^\circ$ .



- The laser is not active in the Inclination (INC) Measurement Mode.
- Generally, the instrument measures inclination when you press . However, in (1) the Continuous Target Mode and (2) in the Height Measurement Mode, the inclination reading appears in the Main Display and the display updates as your aiming point changes as long as you press . In these two situations, the measured inclination is based upon the aiming point when you release .



## Compass

The TruPulse 360 utilizes the latest in electronic compass technology. The internal circuitry provides 3-axis monitoring of the earth's magnetic field and uses proprietary calibration algorithms to produce the best possible azimuth accuracy while having a simple field calibration procedure. The TruPulse 360 evaluates the local magnetic environment during each field calibration and provides user feedback of the quality of the calibration. In addition, the instrument has built-in system tests, which continually monitor the integrity of the compass calibration and alert a user if a re-calibration is required. The TruPulse 360 helps you to produce quality field results by keeping a constant watch on its internal status.











## TruVector™ Technology

Incorporated into the TruPulse 360 is LTI's TruVector technology. This allows the instrument to take an accurate azimuth and inclination reading no matter how it is oriented in physical space. The TruPulse 360 can be tilted, rolled, or even upside down and it will still measure the correct azimuth and inclination in the direction that you are viewing. This is accomplished by combining a 3-axis magnetic sensor with a 3-axis tilt sensor – so the TruPulse 360 always knows its position in 3D space, and the direction of the Earth's magnetic field – no matter how it is oriented. TruVector technology allows you the ultimate freedom to “shoot from any angle.”

## Digital Processor

The TruPulse includes LTI's proprietary ASIC chip (Application-Specific Integrated Circuit). The ASIC chip combined with high-speed CPU processing allows the TruPulse to deliver accurate and fast measurements.

## Section 2 - Quick Start

1. Install the batteries (page 9).
2. Press  to power ON the TruPulse.
3. Select a target such as a tree or a building. For this example, the target should be approximately 250 feet (82 yards or 75 meters) from you.
4. Look through the eyepiece (see Figure #2) and use the crosshair to aim to the target. The in-scope LCD should look similar to Figure #3A.
  - o If the HD indicator is not displayed, press  or  until the HD indicator is displayed.
5. Press-and-hold . The LASER status indicator is displayed while the laser is active (Figure #3B). The laser remains active for a maximum of 10 seconds while acquiring data about the target.
  - o If the target is not acquired, release  and repeat this step.
6. Release  once the distance is displayed (Figure #3C). The measurement flashes one time and then is displayed steady until you press a button or the unit powers OFF.
  - o Press  or  to scroll through the measurement modes and see the results acquired for each function.
  - o Repeat steps #3-#6 above to take another measurement.
  - o Simultaneously press-and-hold  and  for 4 seconds to power OFF the TruPulse.

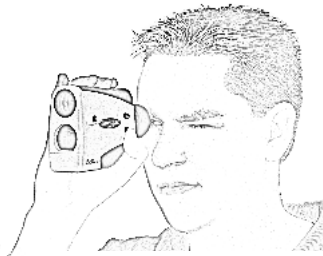

Figure #2

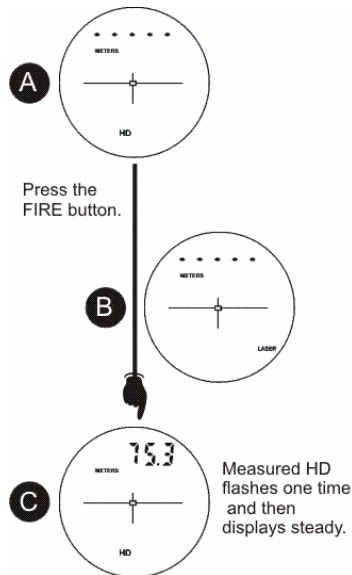

Figure #3

## Section 3 - Basic Operations

### Batteries

#### Installation

You may use two AA batteries (or one CRV3 battery) to power the TruPulse. The CRV3 battery provides approximately twice the usage time of the AA batteries.

1. Remove the battery compartment cover by gently pressing and sliding the cover in and down as shown in Figure #4A.
2. *If using AA batteries*, install the batteries as shown in Figure #4B. Batteries must be oriented (+/-) as shown in Figure 4B and on the indication sticker found inside the battery compartment.
  - o *If using one CRV3 battery*, the battery compartment is designed so the battery only fits one way.
3. Replace the battery compartment cover by aligning the tabbed edges of the cover with the grooved edges of the battery compartment, and slide the cover up until the tab locks into position.

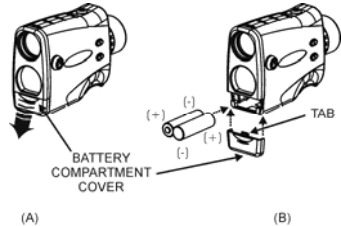

Figure #4

#### Low Battery Warning

The TruPulse monitors the incoming battery voltage. Figure #5 shows the location of the battery status indicator.

- *When the voltage drops below 2.2V*, the BATT status indicator flashes every 5 seconds, alternating with the normally displayed information.
  - o You should replace the batteries as soon as possible.
- *When the voltage drops below 2.0V*, the BATT status indicator stops flashing and is displayed steady. At this point, system operation is locked.
  - o You must replace the batteries to return to normal system operation.

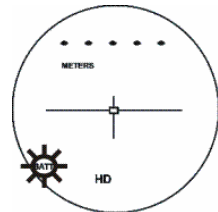





Figure #5

## Buttons

The TruPulse has three buttons. With the TruPulse in your right hand and looking through the eyepiece,  is located on top, near your index finger and  and  are located on the left side of the instrument.



<b>Measurement Modes</b>	Powers ON the unit. Distance Measurement: fires the laser. Inclination: Release “locks” tilt sensor in (1) Height Measurement Mode and (2) Continuous Target Mode.
<b>Height Routine</b>	(HD) Fires the laser. (INC) Release “locks” tilt sensor.
<b>Target Modes System Setup Modes</b>	Selects option and returns to the Measurement Mode.
<b>Calibration Routines</b>	When “no”CAL” or “YES”CAL” displayed, press to begin the Calibration Routine.
	When “PASS” message displayed, exits the routine and returns to the Measurement Mode.
	When “FAiL” message displayed, the “no”CAL” option is displayed.





(UP)



<b>Measurement Modes</b>	Press to scroll to the previous Measurement Mode.
	Press-and-hold 4 seconds to access the Target Mode.
<b>Height Routine Missing Line Routine</b>	Clears the last measurement and re-displays the previous prompt.
<b>Target Modes System Setup Modes</b>	Press to scroll to the previous option.
<b>Calibration Routines</b>	When “no”CAL” or “YES”CAL” displayed, press to scroll to the previous option.
	Press-and-hold 4 seconds to abort the calibration and return to the Measurement Mode. Previous calibration is restored.



<b>Measurement Modes</b>	Press to scroll to the next Measurement Mode.
	Press-and-hold 4 seconds to access the System Setup Modes.
<b>Height Routine</b>	Exits the Height Routine.
<b>Target Modes</b> <b>System Setup Modes</b>	Press to scroll to the next option.
<b>Calibration Routines</b>	When “no””CAL” or “YES””CAL” displayed, press to scroll to the next option.
	Press-and-hold 4 seconds to abort the calibration and return to the Measurement Mode. Previous calibration is restored.

Note: It is possible to restore the TruPulse 360's default settings. Simultaneously press-and-hold the , , and  buttons. For more information, [see page 16](#).

### Powering OFF the TruPulse

To power OFF the unit, simultaneously press-and-hold  and  for 4 seconds. To conserve battery power, the TruPulse powers itself OFF if no button presses are detected after a specified length of time:

- TruPulse 360 (or 360B with Bluetooth OFF): 2 minutes
- TruPulse 360B with Bluetooth ON: 30 minutes

### Display Indicators

Figure #6 shows the LCD in-scope display. The TruPulse's internal software is organized into options. Each option represents a specific measurement or setup function and has a corresponding display indicator. Refer to the figure and table below for information about each indicator.

Note: A liquid crystal display (LCD) is mounted within the optical system and when activated, displays a reticle for targeting, yards / meters, and the display indicators. Inherent in the manufacturing process are small black spots that appear in the optical system. These are a natural characteristic of the LCD and cannot be fully eliminated in the manufacturing process. These small black spots do not affect the distancing performance of the unit.

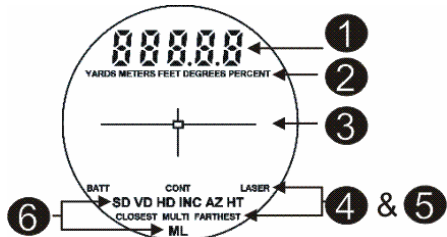

Figure #6

**1 Main Display**

888.8.8	Displays messages and measurement results.
---------	--

**2 Measurement Units**

YARDS METERS FEET	Distance measurement units. Selection available in the System Setup Modes.
DEGREES PERCENT	Inclination measurement units. Selection available in the System Setup Modes



**3 Crosshair**

	Serves as the aiming point reference, both horizontally and vertically.
---	---

**4 Status Indicators**

BATT	<i>Flashing:</i> battery voltage is low. <i>Steady:</i> battery voltage is too low for system operation. <i>Not Visible:</i> battery voltage is within acceptable range.
LASER	<i>Visible:</i> laser is firing. <i>Not Visible:</i> laser is not active.
MULTI	Multiple targets have been logged in the Closest or Farthest target mode.

**5 Target Modes**

CONT	The unit continuously acquires targets and displays measurements while  is held down. The distance to the most recently acquired target is displayed.
CLOSEST	The unit logs multiple targets while  is held down. Of the targets acquired, the distance to the closest target displays.
FARTHEST	The unit logs multiple targets while  is held down. Of the targets acquired, the distance to the farthest target displays.



<i>Filter</i>	'F' appears as the left-most character of the Main Display to indicate Filter Mode is active. Similar to Standard, single shot mode, but the laser's sensitivity is reduced so it only detects pulses returned from a reflector. The optional foliage filter must be used in conjunction with this mode.
<i>Standard (No display indicator)</i>	Standard, single shot strongest target mode.

## 6 Measurement Modes

SD Slope Distance	Straight line distance between the TruPulse and the target.
VD Vertical Distance	The distance between the target and the perpendicular to the path of the horizontal distance.
HD Horizontal Distance	The level distance between the TruPulse and the plane of the target.
INC Inclination	The angle of inclination between the TruPulse at level and the target.
AZ Azimuth	<p>The magnetic heading to the target referenced to magnetic North.</p> <p><i>Flashing:</i> The TruPulse is in need of a Horizontal Angle Compass Calibration (see page 29). The AZ indicator flashes two times, stops, and then flashes again. This continues until a successful calibration is performed. You can still take measurements during this time.</p> <p>The TruPulse detects when the battery voltage has dropped, or battery door has been opened, and/or if there has been a significant temperature change that affects the accuracy of the compass.</p>
HT Height	Three-step Height Routine. The final calculation represents the vertical distance between the points on the target represented by ANG1 and ANG2.
ML Missing Line	Two-step Missing Line Routine finds the connecting vector (or missing line) between two points. The final calculation shows the SD, VD, HD, INC, and AZ associated with the missing line.

## Display Indicator Test

To verify that all display indicators are working properly:

1. Start with the TruPulse powered OFF, press-and-hold .
2. Compare the in-scope display to the Figure #6 (see page 11) to verify that all indicators are working properly.
3. Release  to start normal operation.

### Eyepiece

The adjustable eyepiece (see Figure #7) is designed for comfort and to block extraneous light. To extend the eyepiece, turn the eyepiece counter-clockwise while pulling up. To return the eyepiece to its original position, turn the eyepiece clockwise and push down. To match your personal preference, the eyepiece may be located in any position from fully up to fully down. If wearing eyeglasses or sunglasses, the fully down position brings the eyepiece lens closer to your eye and gives you a full field of view.

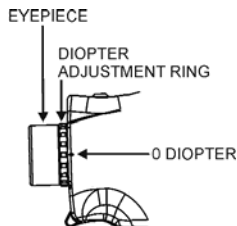

Figure #7



### **Eyepiece Cover:**

**The eyepiece cover protects the internal components from sunlight exposure. The eyepiece cover should be in place whenever the TruPulse is not in use.**

To attach the eyepiece cover:

Feed the thin cord under the metal bar and flare the loop open. Pull the eyepiece cover through the loop and cinch tight.







## Diopter Adjustment Ring

The diopter adjustment ring (see Figure #7 on the previous page) allows you to focus the LCD in-scope display relative to the target for your eye. During assembly, optimum focus is set to infinity. To adjust the LCD focus, turn the diopter adjustment ring to suit your personal preference.

## Firmware Revision Numbers

The firmware revision numbers provide manufacturing information about your TruPulse. To display the main and auxiliary firmware revision numbers:

1. Start with the TruPulse powered OFF, press-and-hold 
  - o Do not release  until done. If you release the button too early, power OFF the TruPulse and repeat step #1.
2. Looking through the eyepiece:
  - o Press  to display the main firmware revision number. The display should look similar to the example below. The leftmost character should always be 'A' and the remaining three digits represent the main firmware revision number (3.05 in Figure #8).
  - o Press  to display the auxiliary firmware revision number. The display should look similar to the example above. The leftmost character should always be 'b' and the remaining three digits represent the auxiliary firmware revision number (3.37 in Figure #8).

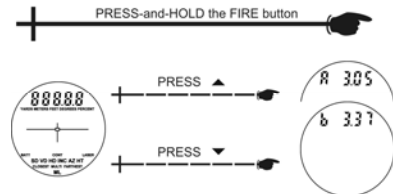

Figure #8

## Measuring Point

The measuring point of the TruPulse is located at the center point of the instrument, the 1/4-20 thread.

## Neck Strap

To attach the neck strap:

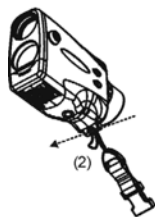

- (1) Disconnect anchor end of the strap using the buckle.
- (2) Feed loop around metal bar.
- (3) Thread the neck strap through the loop.
- (4) Gently tighten to secure.
- (5) Reconnect anchor end of the strap using the buckle.

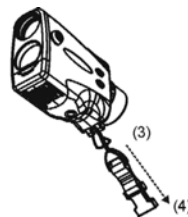

Figure #9

## Restore Default Settings

It is possible to restore the TruPulse 360's default settings. Restoring the default settings affects some of the system setup options.

The table below lists the parameters and the associated default settings. The third column lists the page reference for additional information.



Parameter	Default Value	Refer to Page Number
Measurement Mode	HD	<a href="#">32</a>
Distance Units	Yards	<a href="#">18</a>
Inclination Units	Degrees	<a href="#">18</a>
Bluetooth	oFF	<a href="#">19</a>
Declination	0.00	<a href="#">24</a>



Restoring default settings:





- Does not effect Tilt Sensor calibration or Horizontal Angle Compass Calibration.
- Does cancel/clear serial command to Bluetooth ALL ON.

To restore the default settings:

1. Simultaneously press-and-hold the , , and  buttons for approximately 5 seconds.

## Section 4 - System Setup

Figure #10 shows an overview of the System Setup Mode which can be accessed from the Measurement Mode. Each option is described separately in the following sections.

1. From the Measurement Mode, press and hold  for 4 seconds. "UnitS" will appear in the Main Display as shown in Figure #10 below.
2. Press  or  to display the previous or next option.
3. Press  to select an option.

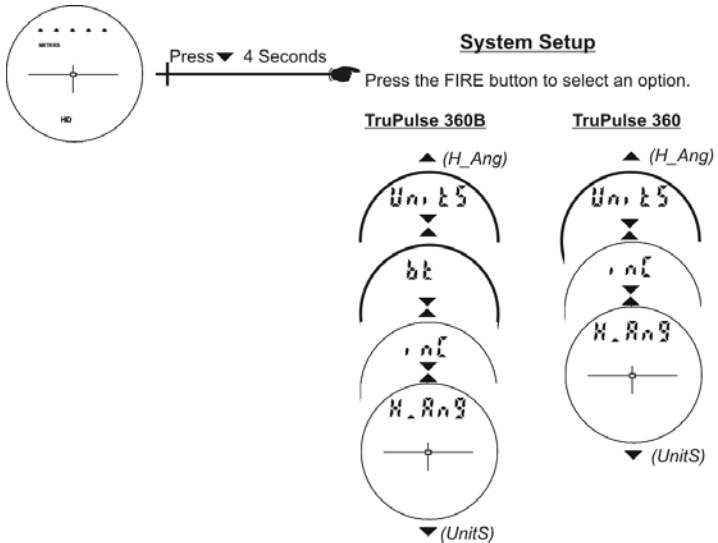







Figure #10

## Select Measurement Units

The TruPulse allows you to choose between YARDS, METERS, and FEET for distance measurements. To toggle the units selection:

1. From the Measurement Mode, press  for 4 seconds to access the System Setup Mode. "UnitS" will appear in the Main Display as shown in Figure #11 below.
2. Press  to select the "UnitS" option.
3. Press  or  to display the previous or next distance unit option.
4. Press  to select the displayed distance unit and return to the Measurement Mode.

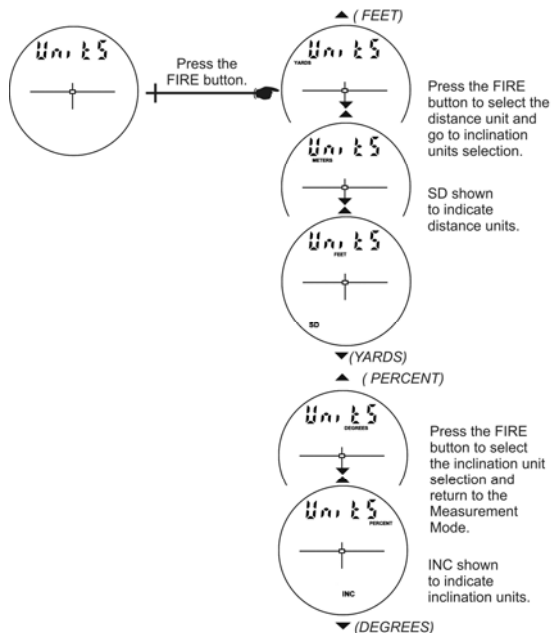

Figure #11



Each time the TruPulse is powered ON, it will return to the same unit setting that was last used.







## Enable Bluetooth

\*\*\*TruPulse 360B only\*\*\*

Bluetooth wireless technology is an industry standard specification for short-range wireless connectivity. As a short-range radio link, Bluetooth replaces cable connections between devices allowing you to download measurement data to any Bluetooth enabled PC device such as a laptop PC, Pocket PC, etc.

- TruPulse Bluetooth offers serial port service to connect to an RS-232 style serial connection. It replaces the download cable from the TruPulse to any Bluetooth enabled PC device.
- TruPulse Bluetooth is a slave device. Bluetooth master devices can detect the TruPulse when the TruPulse is powered ON and the Bluetooth option is enabled.

To toggle the Bluetooth selection:

1. From the Measurement Mode, press  for 4 seconds to access the System Setup Mode. "UnitS" will appear in the Main Display.
2. Press  to display the "bt" option as shown in Figure #12 below.
3. Press  to select the Bluetooth Enable Mode.
4. Press  or  to display the other "bt" option.
5. Press  to select the "bt\_on" or "btOFF" and return to the Measurement Mode.

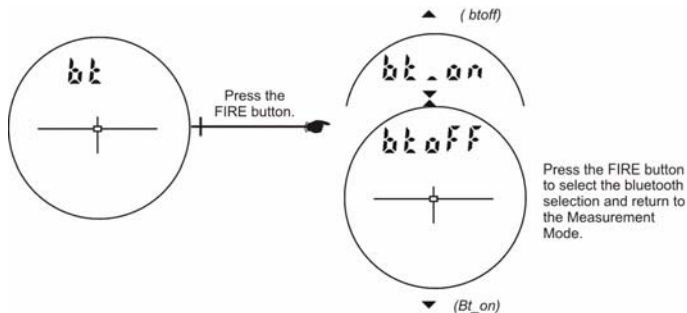

Figure #12



- Each time the TruPulse 360B is powered ON, it will return to the same Bluetooth setting that was last used.
- Bluetooth Version 2.0 Class 2.

Refer to the instructions below when connecting your TruPulse 360B to another Bluetooth device. This information is provided as a general guideline.



Refer to the third party product documentation for your specific Bluetooth device.

1. Toggle the TruPulse Bluetooth option ON and return to the measurement mode (see previous page). A host device can now detect the Bluetooth communication from the TruPulse.
  - Refer to the host device documentation for connecting to Bluetooth devices.
2. Use the Bluetooth Manager to scan for the TruPulse Bluetooth module. The TruPulse Bluetooth will be named “TP360B000000” where “000000” is the serial number of your TruPulse 360B.
3. Tap the icon that matches your TruPulse Bluetooth device.
4. You **may** be prompted to enter:
  - Passkey = 1111
  - Service Selection = SPP Slave
  - Select (long press) “Connect”. The Bluetooth Manager on the host device should find and display the active connection status.





Bluetooth troubleshooting tips:

- TruPulse: Verify that the TruPulse Bluetooth option is toggled ON.
- Bluetooth enable PC device: Verify that the Bluetooth connection is active.
- Verify that the Bluetooth device is physically located within the wireless transmission range of the TruPulse.
  - Transmission range can vary depending upon (1) position relative to the TruPulse or (2) type of Bluetooth® connection.

### Align the Tilt Sensor

The tilt sensor is aligned during assembly. In the rare event that your TruPulse suffers a severe drop shock, refer to the instructions below to re-align the tilt sensor.

1. From the Measurement Mode, press  for 4 seconds to access the System Setup Mode. "UnitS" will appear in the Main Display.
2. Press  to display the "inc" option as shown in Figure #13 below.
3. Press  to select the "inc" option. The message "no" "CAL" appears in the Main Display and the display should look similar to Figure #13.

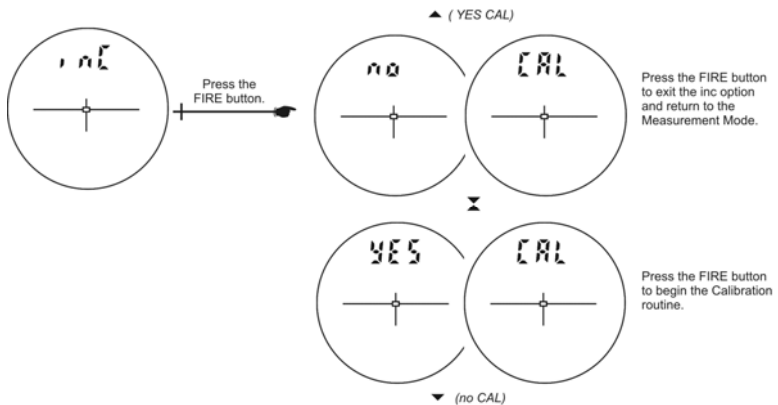





Figure #13

Press  or  to display the previous or next "CAL" option.

If "no" "CAL" is displayed, press  to exit the "inc" option and return to the Measurement Mode.

If "YES" "CAL" is displayed, press  to begin the Tilt Calibration Routine.

The message "C1\_Fd" appears in the Main Display.

### Tilt Sensor Calibration Routine

Figure #14 shows the steps required to complete the Calibration Routine. The instructions are on the next page.

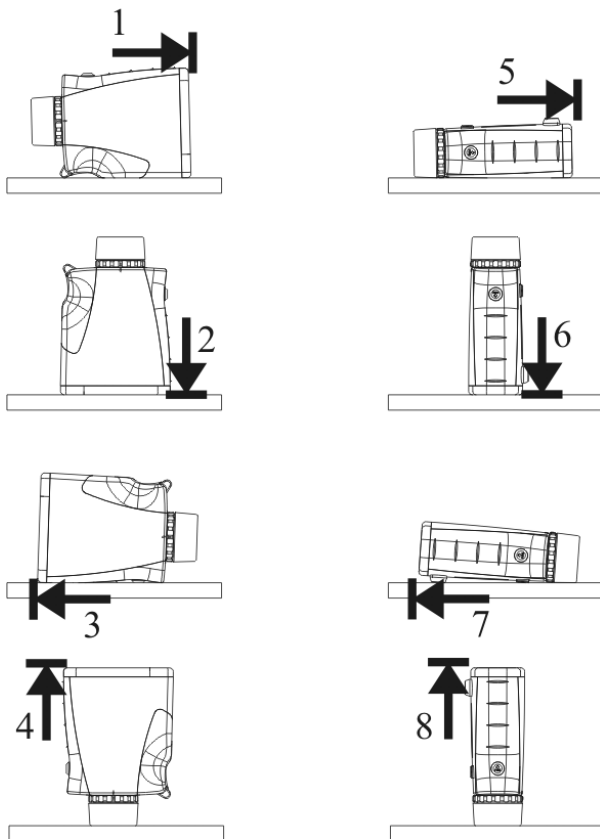

Figure #14





- At each step, wait approximately 1 second before pressing the button. Then wait another second before moving to the next position. It is important that the unit is held steady when the button is pressed.
- The Tilt Calibration routine can be aborted at any time during the procedure with a long press of or . If the calibration is aborted, the unit restores the previous stored calibration.

1. Position the TruPulse on a flat, relatively level surface (15 degrees of level). The lenses should be facing forward as shown in Figure #14-1. Press to store the first calibration point.
2. Rotate the TruPulse 90 degrees, the lenses should be facing down as shown in Figure #14-2. Press to store the second calibration point.
3. Rotate the TruPulse 90 degrees, the lenses should be facing back as shown in Figure #14-3. Press or to store the third calibration point. Be careful to do a short press when you press the or . If you do a long press, the calibration routine will be aborted.
4. Rotate the TruPulse 90 degrees, the lenses should be facing up as shown in Figure #14-4. Press to store the fourth calibration point.
5. Rotate the TruPulse 90 degrees along the optical axis, the lenses should be rotated, facing forward as shown in Figure #14-5. Press to store the fifth calibration point.
6. Rotate the TruPulse 90 degrees, the lenses should be facing down as shown in Figure #14-6. Press to store the sixth calibration point.
7. Rotate the TruPulse 90 degrees, the lenses should be facing back as shown in Figure #14-7. Press to store the seventh calibration point.
8. Rotate the TruPulse 90 degrees, the lenses should be facing up as shown in Figure #14-8. Press to store the eighth calibration point.
9. Look through the eyepiece, either a pass or fail message appears in the Main Display.
  - PASS: Press the to return to the Measurement Mode.
  - FAiL1: Excessive motion during calibration. Unit was not held steady.
  - FAiL2: Magnetic saturation error. Local magnetic field too strong.
  - FAiL3: Mathematical fit error.
  - FAiL4: Calibration convergence error.
  - FAiL6: Orientations were wrong during the calibration.

If a "FAiL" message appears, press The message "no""CAL" will be displayed allowing you to do a new calibration. See step # 3 [page 21](#). If the calibration fails, the previous calibration is restored.

## Horizontal Angle Menu

As shown in Figure #15, the Horizontal Angle Menu includes options that affect compass operation: Declination Menu and Horizontal Angle Compass Calibration Menu.

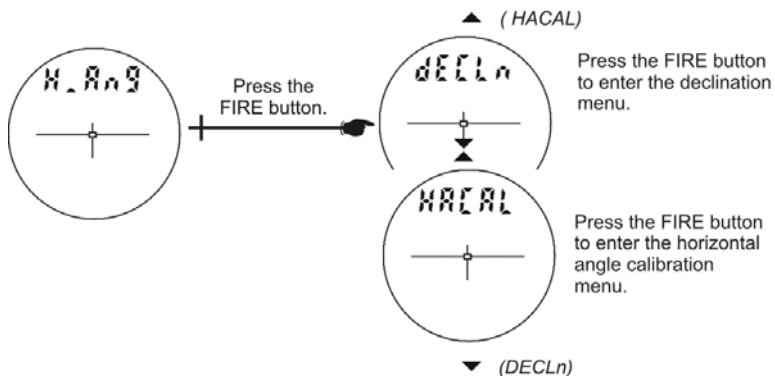





Figure #15

## Declination Menu

1. From the Measurement Mode, press  for 4 seconds to access the System Setup Mode. "UnitS" will appear in the Main Display.
2. Press  to display the "H\_Ang" option.
3. Press  to select the "H\_Ang" option. The message "dECLn" appears in the Main Display
4. Press  to select the "H\_Ang" option. The message "no" "dECLn" appears in the Main Display and the display should look similar to Figure #16 (see next page).

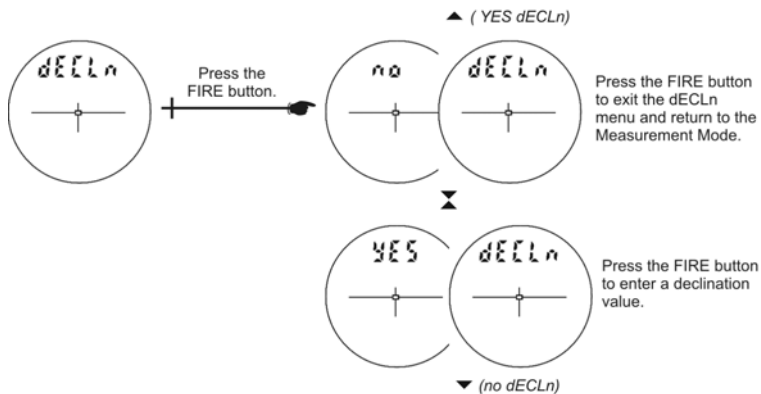

Figure #16

Press or to display the previous or next "dECLn" option.

If "no" "dECLn" is displayed, press to exit the "dECLn" menu and return to the Measurement Mode.

If "YES" "dECLn" is displayed, press to enter a declination value ([page 27](#)).

### About Magnetic Declination

The magnetic poles are not located at the same place as the geographic North and South poles. Moreover, they move in a predictable direction by a small amount annually. A compass always points toward the magnetic pole. The direction that the compass points is called a magnetic meridian. True North, or geographic North, relative to magnetic North varies somewhat depending on your location on the surface of the earth. Declination is the value of the variation between Magnetic North and True North, expressed in degrees or degrees west of True North.

It is important that you determine the correct declination value for the area that you are working in and enter this value into the TruPulse 360. You need to know your local latitude and longitude in order to determine the magnetic declination. This must be done prior to using the instrument for azimuth measurements.

### **Example Declination Value**

Magnetic declinations are east (positive) if the compass measures east of true North, and west (negative) if the compass measures west of true North.

-  At the time this manual was published, Denver, Colorado, which is in the western part of the continental US, had a declination value of 9°9' east, which is represented as a positive value. The zero declination line runs generally north and south somewhere west of Chicago.

### **Online Declination Software**

NOAA's National Geophysical Data Center (NGDC) website includes online declination software that computes the estimated declination for your location. You only need to enter the location (US zip code) and date of interest.

-  At the time this manual was published, the website address was:  
<http://www.ngdc.noaa.gov/geomagmodels/Declination.jsp>.
- Although the software is setup for US zip codes, it also provides a link for locations outside of the USA.

## Entering a Declination Value

When the Declination Menu is displayed and "YES dECLn" appears in the Main display, press  to enter a declination value.

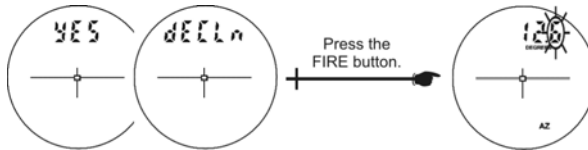











Figure #17

 The declination value can be aborted at any time during the procedure with a long press of  or . If the value is aborted, the unit restores the previously stored declination value.

1. The right-most digit flashes, indicating that it can be edited.  
Press  /  to increase/decrease the flashing digit.
2. Press  to accept the digit edit and move the edit to the next significant digit.
3. After the 3rd significant digit is edited, the entire value flashes.  
Note: The edit range is  $\pm 39.9$  degrees.
4. Press  /  to toggle the value from positive (+) to negative (-).
5. Press  to accept the final value.

 When an azimuth measurement is displayed, "d" appears as the left-most character in the Main Display as a reminder that a declination value has been entered.

### Local Magnetic Attractions

Local magnetic attractions are caused by objects of iron, steel, cobalt, nickel, and other ferro-magnetic materials. Electric utility lines may also affect compass readings. Direct current power utility lines will cause a fixed offset, and alternating currents will cause an unstable compass reading. The effect that local attraction has on the compass depends upon the proximity of the material to the compass and on the mass and strength of the local attraction. Small metallic objects carried on or by the operator may affect the compass reading by as much as several degrees. In some work situations, the strength of the interference could prevent the compass from providing a useful azimuth. Usually the potential for local attraction can be determined by visually inspecting the site or from local knowledge of any buried utilities.



The following objects may potentially affect the TruPulse 360's performance and should be avoided:

- Batteries
- Data collectors or computers
- Hatchets
- Homemade yokes
- Magnetic antenna mounts
- Metal watch bands
- Tripods
- Nails
- Pin flags
- Portable radios
- Steel-rimmed eyeglasses or spring hinge
- Tripod tribrachs





It is recommended that the data collector be located a minimum of 18 inches (46 centimeters) away from the TruPulse.

### **Field Tests for Local Magnetic Conditions**

The following simple tests can be used in the field to test for local magnetic interference.

- If you are working on a street, and you know its orientation relative to true North, aim down the street and take a measurement. Nearly 80% of the streets in the US are oriented in a north-south or east-west direction.
  - The azimuth from the compass should match the known direction of the street.
- Choose a target at least 100 meters away (e.g., a pole) and shoot to it. Note the azimuth. Then step backwards or forwards 1 meter (or 1 yard) along the sight line to the target and shoot again.
  - The second azimuth should be within 1/10th to 5/10ths of a degree of the first azimuth. If it is, you are very likely within an anomaly-free area.
  - For increased confidence, repeat the test to a target at 90 degrees to the azimuth of the first target.
- This third test can be performed if you are in a questionable area. Aim and measure to your prospective next target and note the azimuth. Move to the next station and measure back to the original station.
  - The azimuths should be 180 degrees different, plus or minus a few tenths of a degree.

## Horizontal Angle Compass Calibration Menu

1. From the Measurement Mode, press  for 4 seconds to access the System Setup Mode. "UnitS" will appear in the Main Display.
2. Press  to display the "H\_Ang" option.
3. Press  to select the "H\_Ang" option. The message "dECLn" appears in the Main Display.
4. Press  to display the "HACAL" option.
5. Press  to select the "HACAL" option. The message "no" "CAL" appears in the Main Display and the display should look similar to Figure #18.

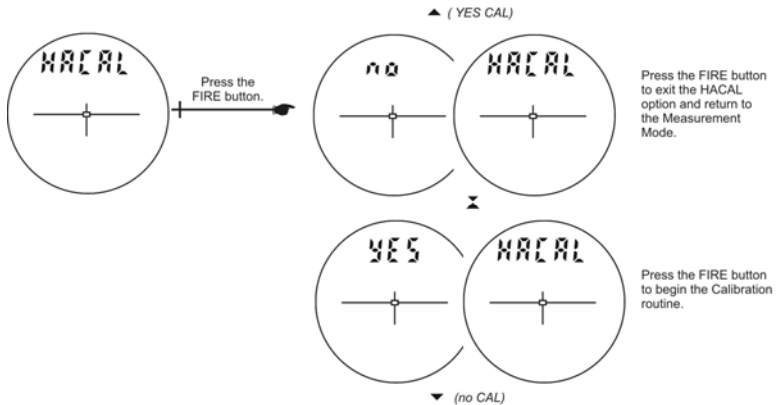





Figure #18

Press  or  to display the previous or next "HACAL" option.

If "no" "dECLn" is displayed, press  to exit the "HACAL" menu and return to the Measurement Mode.

If "YES" "CAL" is displayed, press  to begin the horizontal angle compass calibration routine. The message "C1\_Fd" appears in the Main Display.

### Horizontal Angle Compass Calibration Routine

Figure #19 shows the steps required to complete the Horizontal Angle Compass Calibration Routine. To begin the routine, you should be holding the TruPulse and facing North. The instructions are on the next page.

1



TruPulse  
Facing  
North

5



TruPulse Facing North  
Serial Port Pointing Up

2



6



3



7



4



8

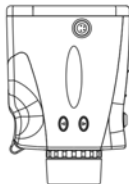















Figure #19



- At each step, wait approximately 1 second before pressing the  button. Then wait another second before moving to the next position. It is important that the unit is held steady when the  button is pressed.
  - The Horizontal Angle Compass Calibration routine can be aborted at any time during the procedure with a long press of  or . If the calibration is aborted, the unit restores the previous stored calibration.
1. Holding the TruPulse and facing close to magnetic North ( $\pm 15$  degrees towards North). The lenses should be facing as shown in Figure #19-1. Press  to store the first calibration point.
  2. Rotate the TruPulse 90 degrees, the lenses should be facing down as shown in Figure #19-2. Press  to store the second calibration point.
  3. Rotate the TruPulse 90 degrees, the lenses should be facing back as shown in Figure #19-3. Press  to store the third calibration point.
  4. Rotate the TruPulse 90 degrees, the lenses should be facing up as shown in Figure #19-4. Press  to store the fourth calibration point.
  5. Rotate the TruPulse 90 degrees along the optical axis, the lenses should be rotated, facing forward and the serial port pointing up as shown in Figure #19-5. Press  to store the fifth calibration point.
  6. Rotate the TruPulse 90 degrees, the lenses should be facing down as shown in Figure #19-6. Press  to store the sixth calibration point.
  7. Rotate the TruPulse 90 degrees, the lenses should be facing back as shown in Figure #19-7. Press  to store the seventh calibration point.
  8. Rotate the TruPulse 90 degrees, the lenses should be facing up as shown in Figure #19-8. Press  to store the eighth calibration point.
  9. Look through the eyepiece, either a pass or fail message appears in the Main Display.
    - PASS: Press the  to return to the Measurement Mode.
    - FAiL1: Excessive motion during calibration. Unit was not held steady.
    - FAiL2: Magnetic saturation error. Local magnetic field too strong.
    - FAiL3: Mathematical fit error.
    - FAiL4: Calibration convergence error.
    - FAiL6: Orientations were wrong during the calibration.

If a "FAiL" message appears, press . The message "no"CAL" will be displayed allowing you to do a new calibration. See step # 5 [page 29](#). If the calibration fails, the previous calibration is restored.

## Section 5 - Measurement Modes

When you power ON the TruPulse, the last used Measurement Mode will be active. Press **▲** or **▼** to display the previous or next Measurement Mode. Figure #20 shows six different types of measurements that the TruPulse can take. For information about the Missing Line Routine, see page 36.

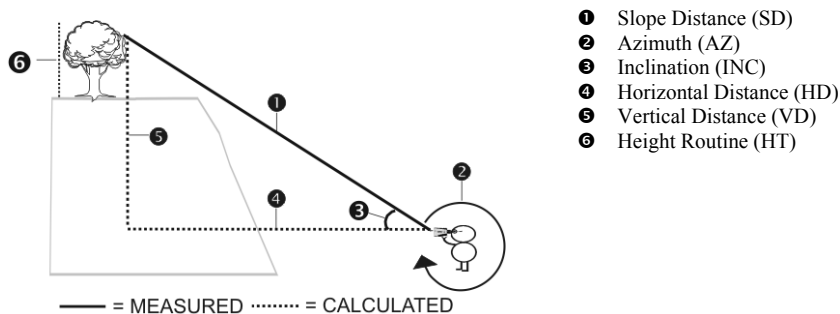

- 1 Slope Distance (SD)
- 2 Azimuth (AZ)
- 3 Inclusion (INC)
- 4 Horizontal Distance (HD)
- 5 Vertical Distance (VD)
- 6 Height Routine (HT)







Figure #20

### Distance Measurements



The basic steps for taking any distance measurement:

1. Look through the eyepiece and use the crosshair to aim to the target.
2. Press-and-hold **🔴**. The LASER status indicator is displayed while the laser is active. The laser remains active for a maximum of 10 seconds while acquiring data about the target.
  - o If the target is not acquired in the 10-second period, release **🔴** and repeat this step.
3. Once the measurement is displayed, release **🔴**. The measurement flashes one time, indicating the measurement was downloaded. Then the measurement is displayed steady until you press any button or the unit powers OFF.

### Notes about Measurements

- 
  - Press  or  to scroll through the individual measurement functions and see the results acquired for each function.
    - Azimuth, inclination, and distance are measured in the HD, SD, VD modes.
    - Example Range Measurement: HD = 12.5 meters
      -  VD = 1.6 meters
      -  SD = 12.6 meters
      -  INC = 7.3 degrees
      -  AZ = 163.6 degrees
    - When you scroll to the Height Function, the Main Display will be blank and the HD indicator will be flashing.
    - In the Inclination Mode, the Main Display is blank for all other measurement functions (except AZ) since the laser is not active when measuring inclination only.
    - In Azimuth mode, the Main Display is blank for all other measurement functions since the laser is not active when measuring azimuth only.
    - In the Missing Line Mode, the "SHot\_1" appears in the Main Display and the HD indicator is flashing.
  - The last measurement does not need to be cleared before acquiring your next target.
  - Each time the TruPulse is powered ON, it returns to the same measurement mode that was last used.
  - The measuring point of the TruPulse is located at the center point of the instrument, the 1/4-20 thread.

### Inclination Measurements



The laser is not active in the Inclination (INC) Measurement Mode. Generally, the inclination is measured when you press . However, in (1) the Continuous Target Mode and (2) in the Height Measurement Mode, the inclination reading appears in the Main Display and the display updates as your aiming point changes as long as you press .

### Percent Slope

Percent slope (indicated by "PERCENT") is a calculation equal to 100 times the tangent of the inclination angle. It is a variant way of expressing the inclination. You can get percent slopes only in the basic measurement displays, never in the Height measurement displays. Note also that the instrument never downloads a percent slope. It always downloads the inclination angle.

- 
  - An inclination angle of 5 degrees, for example, is equal to a slope of about 8.75 percent.

## Azimuth Measurements

The laser is not active in the Azimuth (AZ) Measurement Mode. Generally, the azimuth is measured when you press . However, in the Continuous Target Mode, the azimuth reading appears in the Main Display and is updated as your aiming point changes as long as you press .

 As a reminder, "d" appears as the left-most character in the Main Display to indicate that a declination value has been entered.





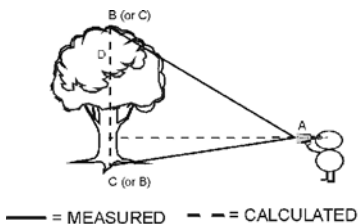

## Height Routine

Height Measurements involve a simple routine that prompts you to take 3 shots to the target: HD, INC base (or top), and INC top (or base). The TruPulse uses these results to calculate the height of the target. Figure #21 shows the three shots required for the Height Routine.



**A** = Horizontal Distance  
**B** = Top Angle  
**C** = Base Angle  
**D** = Height

Figure #21

1. Select your target and look through the eyepiece, using the crosshair to aim to your target. The HT indicator displays steady and the HD indicator flashes; prompting you to measure the Horizontal Distance to the “face” of the target.
2. Press-and-hold . The LASER status indicator is displayed while the laser is active. The laser remains active for a maximum of 10 seconds while acquiring data about the target. The measured horizontal distance appears briefly in the Main Display and then Ang\_1 and the INC indicator flashes; prompting you to measure the inclination to base (or top) of the target.
3. Press-and-hold  and aim to the base (or top) of the target. The measured inclination appears in the Main Display and is updated as long as you continue to hold . The measured inclination is “locked” when you release . The measured inclination appears briefly in the Main Display and then Ang\_2 appears and the INC indicator flashes; prompting you to measure the inclination to the top (or base) of the target.
4. Press-and-hold  and aim to the top (or base) of the target. The measured inclination appears in the Main Display and is updated as long as you continue to hold . The measured inclination is “locked” when you release . The measured inclination appears briefly in the Main Display and then the calculated Height is displayed. The measurement flashes one time and then displays steady until you press any button or the unit powers OFF.

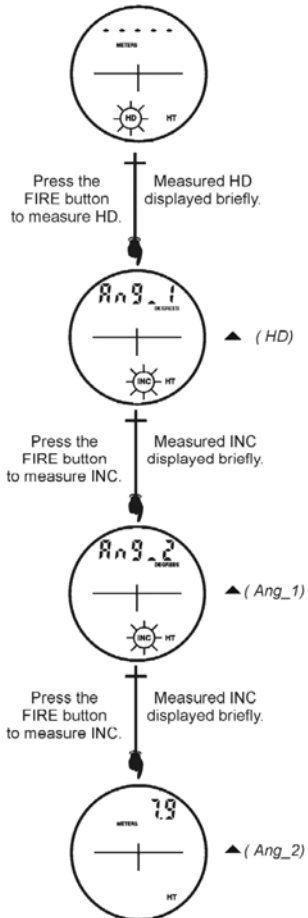

Figure #22



During the Height Routine:

- Press to re-shoot the previous point.
- Press to exit the Height Routine.
- The laser is not active while measuring the ANG1 and ANG2 values. As long as you hold , the inclination reading is displayed and updated as your aiming point changes. The measured inclination is based upon your aiming point when you release .
- When the height result is displayed, just press to start the routine and repeat the steps.

### Missing Line Routine

The Missing Line Routine calculates distances and angles to describe the relationship between two points in three-dimensional space (connecting vector). This routine is ideal for span lengths, remote slope determinations, and changes in elevation from one location.

The simple routine prompts you to take two shots to targets: "Shot 1" and "Shot 2". The TruPulse uses the results to calculate five variables between the two points: slope distance, inclination, azimuth, horizontal distance, and vertical distance as shown in Figure #23.

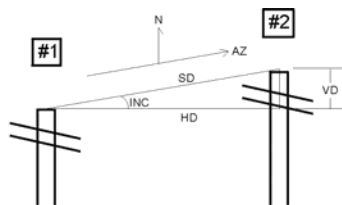
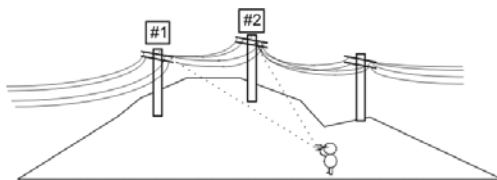





Figure #23

- HD: Horizontal Distance: Horizontal component of the missing line.  
 VD: Vertical Distance: Change in elevation between point #1 and point #2.  
 SD: Slope Distance: Length of the missing line.  
 INC: Inclination between point #1 and point #2.  
 AZ: Relative Azimuth: Direction from the point #1 to point #2.

During the Missing Line Routine:

Press the ▲ to re-shoot Shot 1.

Press the ▲ to exit the Missing Line Routine.

1. Select your first target and look through the eyepiece, using the crosshair to aim to your target. The ML indicator displays steady and the HD indicator flashes; prompting you to measure the Horizontal Distance to the first target.
2. Press-and-hold . The LASER status indicator is displayed while the laser is active. The laser remains active for a maximum of 10 seconds while acquiring data about the target. The measured horizontal distance appears in the Main Display.
3. Once the fire button is released, "Shot2" appears steady and the HD indicator flashes (with ML steady); prompting you to measure the Horizontal Distance to the second target. Looking through the eyepiece and using the crosshair to aim to the second target.
4. Press-and-hold . The LASER status indicator is displayed while the laser is active. The laser remains active for a maximum of 10 seconds while acquiring data about the target. The measured horizontal distance to the second target appears in the Main Display.
5. Once you release , HD and ML are steady and the calculated horizontal distance of the missing line is displayed. The measurement flashes one time and then displays steady until you press any button or the unit powers off.

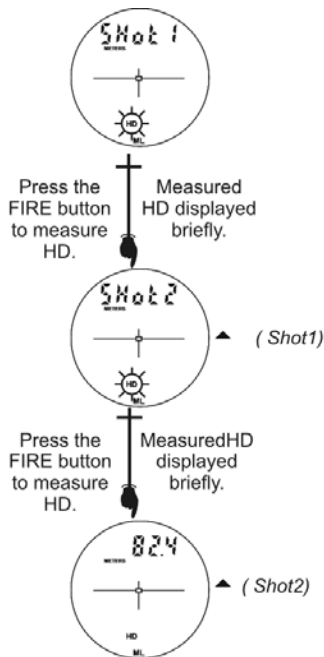







Figure #24

At this time, you can:

- Press  or  to scroll and see the other missing line measurements results (VD, SD, INC, and AZ).
- Reshoot Shot 2 by pressing  or  until Shot 2 and ML appear steady in the display as well as HD flashing, prompting you to measure the horizontal distance to the second target (or new target). Go to #4. above.
- Press  to exit the missing line results and return to Shot 1.

## Improving the Accuracy of Handheld Results

During the Missing Line Routine, it is important that the TruPulse stay positioned above one particular point on the ground.

- Mounting the TruPulse on a monopod or tripod will improve the accuracy of your results. When aiming to target #2, you can rotate the monopod or tripod without changing the location of the TruPulse.
- If you are using the TruPulse handheld, your body will usually have a swinging motion as you aim to target #2. There are some steps you can take that should improve the accuracy of your results:
  1. Before you take "SHot1", drop an object, such as a coin, on the ground.
  2. Place your feet on either side of the coin, so the coin is centered between your feet and the TruPulse is directly above the coin. See Figure #25.
  3. Shoot point #1.
  4. While keeping the TruPulse directly above the coin, aim to target #2. Being careful not to make a big swinging motion, reposition your feet on both sides of the coin. See Figure #25.
  5. Shoot point #2.

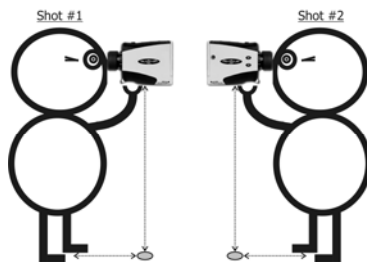

Figure #25









If AZ calculations are not correct, please refer to the Troubleshooting Section, [page 53](#).



## Section 6 - Target Modes

The TruPulse has five Target Modes, which allow you to select or eliminate targets and to take the most accurate measurements possible in various field conditions.

- From the Measurement Mode, press  for 4 seconds. The active Target Mode appears in the Main Display.
- Press  or  to display the previous or next Target Mode.
- Press  to select the displayed Target Mode and return to the Measurement Mode.
  - Std = Standard: Single shot mode.
  - Con = Continuous: Press-and-hold . Once the target is acquired, the TruPulse can continuously acquire additional targets for a maximum of 10 seconds. The most recently acquired target appears in the Main Display.  
Note: The MULTI indicator is not displayed in this mode.
  - CLO = Closest: Press-and-hold . Once the initial target is acquired, the TruPulse can acquire additional targets. The MULTI indicator denotes that additional targets have been acquired. The closest acquired target always appears in the Main Display.
  - FAR = Farthest: Press-and-hold . Once the initial target is acquired, the TruPulse can acquire additional targets. The MULTI indicator denotes that additional targets have been acquired. The farthest acquired target always appears in the Main Display.
  - Flt = Filter: In this mode, the laser's sensitivity is reduced to only detect pulses returned from a reflector. The optional foliage filter must be used in conjunction with this mode. In this mode, measurements always include 'F' as the left-most character in the Main Display. Typical maximum distance is 350 feet to a 3-inch reflector.

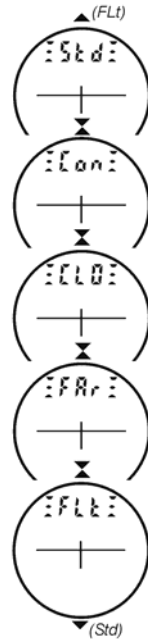

Figure #26



- The selected Target Mode remains active until you repeat the above steps and select a different Target Mode.
- Each time the TruPulse is powered ON, it returns to the same Target Mode that was last used.
- In Closest and Farthest Modes, the minimum separation distance between targets is approximately 20 meters for non-cooperative targets. Cooperative targets could require greater separation.

## Section 7 - Care & Maintenance

The batteries are the only user-replaceable parts in the TruPulse. Do not remove any screws. To do so will effect or void the LTI Limited Warranty.

### **Temperature Range**

The instrument is rated for an operating temperature range of -4° F to +140° F (-20° C to +60° C). Do not expose the TruPulse to temperatures outside this range.

### **Protecting from Moisture and Dust**

The TruPulse is sealed to provide protection from normally expected field conditions. It is protected from dust and rain, but will not withstand submersion.



If water leakage is suspected:

1. Power OFF the TruPulse.
2. Remove the batteries.
3. Air dry the TruPulse at room temperature with the battery compartment open.

### **Protecting from Shock**

The TruPulse is a precision instrument and should be handled with care. It will withstand a reasonable drop shock. If the unit suffers from a severe drop shock, you may need to perform Tilt Sensor Calibration Routine ([page 22](#)) and the Horizontal Angle Compass Calibration Routine ([page 30](#)).

### **Transporting**

When transporting the TruPulse, the unit should be secured in the provided carrying case. The provided neck strap can be used when carrying the TruPulse in the field. The eyepiece cover should be in place whenever the TruPulse is not in use. Never place the TruPulse next to strong magnets, such as an antenna mount.

### **Cleaning**

Clean the TruPulse after each use, before returning it to its carrying case. Check all of the following items:

- *Excess moisture.* Towel off excess moisture, and air dry the instrument at room temperature with the batteries removed and the battery compartment open.
- *Exterior dirt.* Wipe exterior surfaces clean to prevent grit buildup in the carrying case. isopropyl alcohol may be used to remove dirt and fingerprints from the exterior.
- *Transmit and Receive Lenses.* Use the provided lens cloth to wipe the lenses. Failure to keep the lenses clean may damage them.

### **Storing**

If you will not be using the TruPulse again soon, remove the batteries before storing the instrument. Never place the TruPulse next to strong magnets, such as an antenna mount.

## Section 8 - Serial Data Interface

The TruPulse includes a hard-wired serial (RS-232) communication port. Wireless Bluetooth communication is available as an option on the TruPulse 360B. In either case, the measurement data downloaded from the TruPulse is in ASCII Hex format, and duplicates LTI's Criterion 400 (CR400) communication protocol and download messages.

Requirements for transferring serial data using hard-wired connection:

- Serial data transfer cable to connect the TruPulse to the PC, such as:
  - 36-inch LTI 4-Pin to DB9 Download Cable (7053038)
  - 36-inch LTI 4-Pin to DB9 Download Cable with Remote Trigger (7054223)
  - 5-meter LTI 4-Pin to DB9 Download Cable (7054244)
- Data collection software installed on PC, Pocket PC, or other data collection device.

Requirements for transferring serial data using Bluetooth connection:

- See [page 19](#).
- Data collection software installed on a Bluetooth enabled laptop PC, Pocket PC, etc.

### Format Parameters

4800 baud, 8 data bits no parity, 1 stop bit

### Serial Port

Figure #26 shows the pin-out assignments for TruPulse's serial port.

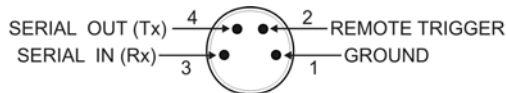

Figure #27

### Download Instructions

The instructions below are provided for general information only. Specific steps may vary, depending upon your data collection program.

1. Connect the TruPulse to the PC, Pocket PC, etc.
2. Start the data collection program on the PC and adjust settings to match format parameters (4800 baud, 8 data bits no parity, 1 stop bit).
3. Power ON the TruPulse.
4. Verify/select measurement units, Measurement Mode, and Target Mode.
5. Take the desired measurement. The measurement result flashes one time indicating that it is being downloaded.

### Optional Remote Trigger

It is possible to remotely trigger the TruPulse and take a measurement by using an external computer, data collector, or switch closure. Remote triggering is accomplished by providing an open collector closure to ground or an active low TTL or RS232 level signal to the 'trigger' pin on the serial connector. This option requires a special order download cable that connects the remote trigger signal from the TruPulse to the 'RTS' output signal of a computer's serial port.

When using a serial cable with a remote trigger connection, care must be taken in controlling the state of the RTS signal from the host computer. Often times the default state of the RTS signal will be low, causing an inadvertent trigger of the TruPulse. Since the remote trigger signal is treated the same as a button press on the TruPulse, holding the signal low is identical to holding down a button, which prevents a response to any additional keys that are pressed.

### Download Message Format

The CR400 data format follows the guidelines of the NMEA Standard for interfacing Marine Electronic Navigational Devices, Revision 2.0. NMEA 0183 provides for both standard and proprietary data formats. Since none of the standard formats are useful for the data transferred from the TruPulse, special proprietary formats are used. Rules described in the NMEA standard governing general message structure, leading and trailing characters, numeric values, delimiting character, checksums, maximum line length, data rate, and bit format are followed exactly. As required by NMEA 0183, the CR400-format does not respond to unrecognized header formats, malformed messages, or messages with invalid checksums.

### Query

The TruPulse accepts Criterion 400 format requests for the firmware version ID. The instrument will not respond to an invalid query. The format is as follows:

**\$PLTIT,RQ,ID<CR><LF>**

<b>\$PLTIT</b>	The Criterion 400 message identifier.
<b>RQ</b>	Indicates a request message.
<b>ID</b>	Indicates the request type.
<b>&lt;CR&gt;</b>	Carriage return.
<b>&lt;LF&gt;</b>	Optional linefeed.

The instrument's response is as follows:

**\$PLTIT, ID, model, versionid \*csum<CR><LF>**

<b>\$PLTIT</b>	The Criterion 400 message identifier
<b>ID</b>	Identifies the message type.
<b>model</b>	Indicates the model.
<i>versionid</i>	The main firmware revision number.
<i>*csum</i>	An asterisk followed by a hexadecimal checksum. The checksum is calculated by XORing all the characters between the dollar sign and the asterisk.
<CR>	Carriage return.
<LF>	Linefeed.

#### **Example Version ID Message**

Request: \$PLTIT,RQ,ID  
Response: \$PLTIT,ID,TP360 MAIN,2.42\*74

## Download Message Formats

### Horizontal Vector (HV) Download Messages

**\$PLTIT,HV,HDvalue,units,AZvalue,units,INCvalue,units,SDvalue,units,\*csum<CR><LF>**

where:

<b>\$PLTIT</b> ,	is the Criterion message identifier.
<b>HV</b> ,	Horizontal Vector message type.
HDvalue, units,	Calculated Horizontal Distance. Two decimal places. F=feet Y=yards M=meters
AZvalue, units,	Measured Azimuth . Two decimal places. Percent slope is not downloaded. D=degrees
INCvalue, units,	Measured Inclination value. Two decimal places. May be positive or negative value. D=degrees
SDvalue, units,	Measured Slope Distance Value. Two decimal places. F=feet Y=yards M=meters
*csum	An asterisk followed by a hexadecimal checksum. The checksum is calculated by XORing all the characters between the dollar sign and the asterisk.
<CR>	Carriage return.
<LF>	Optional linefeed.



- HDvalues, INCvalues, and SDvalues always include two decimal places:  

X.X.YY	
↓	
0	= high quality target
1	= low quality target
- Closest and Farthest Target Modes: multiple targets can be acquired, however, the download message corresponds to the value that appears in the Main Display.

Examples:

High Quality Target:	\$PLTIT,HV,18.00,F,185.20,D,6.90,D,18.00,F*66
Low Quality Target:	\$PLTIT,HV,7.01,M,0.00,D,3.00,D,7.01,M*64
Azimuth Only:	\$PLTIT,HV,,,187.10,D,8.40,D,,,*64
Inclination Only:	\$PLTIT,HV,,,347.20,D,,,,*3F

## Height (HT) Download Messages

**\$PLTIT,HT,HTvalue,units,\*csum<CR><LF>**

where:

<b>\$PLTIT,</b>	is the Criterion message identifier.
<b>HT,</b>	Height message type.
HTvalue,	Calculated Height. Two decimal places.
units,	F=feet Y=yards M=meters
*csum	An asterisk followed by a hexadecimal checksum. The checksum is calculated by XORing all the characters between the dollar sign and the asterisk.
<b>&lt;CR&gt;</b>	Carriage return.
<b>&lt;LF&gt;</b>	Optional linefeed.

Example:

**\$PLTIT,HT,22.10,F\*0C**

## Missing Line (ML) Download Messages

For "SHot1" and "SHot2" refer to Horizontal Vector (HV) Download Message ([page 44](#)).

\$PLTIT,ML,HD,HDunits,AZ,AZunits,INC,INCunits,SD,SDunits\*csum<CR><LF>

\$PLTIT,	is the Criterion message identifier.
ML,	Missing Line message type.
HD,	Specifies horizontal distance measurement value.
HDunits,	Specifies horizontal distance units. F=feet, M=meters, Y=yards.
AZ,	Specifies azimuth measurement value.
AZunits,	Specifies azimuth units. D=degrees.
INC,	Specifies inclination measurement value.
INCunits,	Specifies inclination units. D=degrees.
SD,	Specifies slope distance measurement value.
SDunits	Specifies slope distance units. F=feet, M=meters, Y=yards.
*csum	An asterisk followed by a hexadecimal checksum. The checksum is calculated by XORing all the characters between the dollar sign and the asterisk.
<CR>	Carriage return.
<LF>	Line feed.

Example:

SHot1:	\$PLTIT,HV,6.00,Y,179.40,D,7.20,D,6.10,Y*68
SHot2:	\$PLTIT,HV,5.90,Y,265.70,D,11.60,D,6.00,Y*5D
Calculated Missing Line:	\$PLTIT,ML,8.10,Y,316.90,D,3.20,D,8.10,Y*74



- HDvalues, INCvalues, and SDvalues always include two decimal places:  

X X.YY
↓
0 = high quality target
1 = low quality target
- In the example above, shots 1 and 2 both used high quality targets.



## Uploading Serial Data

1. Download Tera Term Pro:  
[http://www.sofotex.com/Tera-Term-\(Pro\)-download\\_L411.html](http://www.sofotex.com/Tera-Term-(Pro)-download_L411.html)
2. Setup Tera Term Pro.
3. Open the program.
4. Select serial and correct com port and click OK.
5. Enter into the setup tab and select serial and change the baud rate to 4800 or 38400 (whichever you are using), click on OK.
6. Enter into the setup tab again and select terminal, in the new line box and change the transmit and receive to CR+LF.
7. Check local Echo box and click on OK.
8. Type \$ID and enter (If you get a response back, you have communication with the TruPulse).

### Notes:

All commands are preceded with \$

To ask for current value (units for example) just type: \$DU

To change setting to Feet type: \$DU,2

## **Upload Serial Data Commands**

- START\_MEASUREMENT:      GO = Single shot  
(will output "E01" if no target found after 15 seconds)
- STOP\_MEASUREMENT:              ST
- SET\_DISTANCE\_UNITS:              DU
  - Meters:                              0
  - Yards:                                 1
  - Feet:                                    2
- SET\_ANGLE\_UNITS:                 AU
  - Degrees:                              0
  - Percent:                               1
- SET\_MEASUREMENT\_MODE:        MM
  - Horizontal Distance:                0
  - Vertical Distance:                    1
  - Slope Distance:                       2
  - Inclination:                          3
  - Height:                                 4
  - Azimuth:                                5
  - Missing Line:                         6

- SET\_TARGET\_MODE: TM
  - Normal: 0
  - Continuous: 1
  - Closest: 2
  - Farthest: 3
  - Filter: 4
- GET\_BATTERY\_VOLTAGE: BV (millivolts)
  - Example Reply: 3125 = 3.125 volts
- SET\_POWER\_OFF PO

## Section 9 - Specifications

All specifications are subject to change without notice. Please refer to LTI's website for current specifications. If you are not able to locate the information on the website or if you do not have internet access, please contact LTI via phone or fax. Refer to the inside front cover for LTI contact information.

Dimensions:	5" x 2" x 3.5" 12 cm x 5 cm x 9 cm)
Weight:	8 ounces (220 g)
Data Communication:	Serial, via wired RS232 (standard) or wireless Bluetooth® v 2.0 Class 2 (TruPulse 360B)
<b>Power:</b>	3.0 volts DC nominal;
Battery Type:	(1) CRV3 or (2) AA
Battery Duration:	AA: Approximately 43,000 measurements (37,000 with Bluetooth enabled) CRV3: Approximately 86,000 measurements (74,000 with Bluetooth enabled)
<b>Eye Safety:</b>	FDA Class 1 (CFR 21)
<b>Environmental:</b>	Impact, water and dust resistant. NEMA 3, IP 54
<b>Temperature:</b>	-4° F to +140° F (-20° C to +60° C)
<b>Optics:</b>	7X Magnification (Field-of-view: 330 ft @ 1000 yards)
<b>Display:</b>	In-scope LCD
<b>Units:</b>	Feet, Yards, Meters, and Degrees
<b>Monopod/tripod mount:</b>	¼" - 20 female thread

**Measurement Range:**

Distance: 0 to 3,280 ft (1,000 m) typical,  
6,560 ft (2,000 m) max to reflective target  
Inclination:  $\pm 90$  degrees  
Azimuth: 0 to 359.9 degrees

**Accuracy:**

Distance:  $\pm 1$  ft ( $\pm 30$  cm) to high quality targets  
 $\pm 1$  yd ( $\pm 1$  m) to low quality targets  
Inclination:  $\pm 0.25$  degrees  
Azimuth:  $\pm 1$  degree

**Measurement Modes:**

Horizontal Distance, Vertical Distance,  
Slope Distance and Inclination (or Percent Slope),  
3-point flexible Height Routine with auto sequencing,  
and 2-shot Missing Line Routine.

**Target Modes:**

Standard, Closest, Farthest, Continuous, and  
Filter (requires reflector and foliage filter).

**Declaration of Conformity:**

Contact LTI for details. See inside front cover  
for LTI contact information.



## Section 10 – LTI Limited Warranty

### **What is Covered?**

Laser Technology, Inc. (LTI) warrants this product to be in good working order. Should the product fail to be in good working order at any time during the warranty period, LTI will, at its option, repair or replace this product at no additional charge.

Parts and products that have been replaced as a result of a warranty claim become the property of LTI.

### **What is the Period of Coverage?**

This warranty remains in force for one year from the date of purchase from LTI or an authorized LTI product dealer; unless otherwise noted by LTI at the time of sale. LTI reserves the right to require written verification of the date of the original purchase of any product.

### **What is Not Covered?**

LTI has no obligation to modify or upgrade any product once sold. Any reproduction of software products is strictly forbidden. This limited warranty does not include service to repair damage to the product resulting from:

- Accident
- Disaster
- Misuse
- Abuse
- Non-LTI modification
- Batteries or damage caused by batteries used in our products.

In no event will LTI be liable to you for any damages, including any lost profits, lost savings, or other incidental or consequential damages arising out of the use or inability to use such product. Furthermore, LTI shall not be held responsible if an LTI authorized dealer has been advised of the possibility of such damage, or for any claim by any other party.

### **What Will We Do to Correct Problems?**

If this product is not in good working order as warranted above, your sole remedy shall be repair or replacement as provided above.

### **How does State Law Relate to this Warranty?**

LTI hereby disclaims all other express and implied warranties for the product, including the warranties of merchantability and fitness for a particular purpose. Some states do not allow the exclusion of implied warranties, so the above limitations may not apply to you.

### **How do You Get Service?**

In the unlikely event that your LTI product should require warranty or repair service, contact us to receive a Return Merchandise Authorization (RMA) number before returning your product.

If the product is delivered by mail, you agree to insure the product or assume the risk of loss or damage in transit. In addition, the shipping container or equivalent, will be sent prepaid and for door-to-door delivery.





**About the Warranty Validation Card**

It must be completed and received by LTI in order to benefit from this limited warranty. If an LTI software product requires registration, this must also be completed to benefit from this limited warranty. Receipt of the warranty validation card not only activates the limited warranty, it also allows LTI to contact you directly when hardware or software upgrades become available.

If you prefer to register your LTI product electronically, please send an email with all pertinent information to [service@lasertech.com](mailto:service@lasertech.com).

## Section 11 - Troubleshooting

\*\*See [page 20](#) for Bluetooth troubleshooting information.

Problem	Remedy
The unit does not power ON or the LCD does not illuminate.	Press  . Check and if necessary, replace the battery or batteries.
The target cannot be acquired.	Make sure the unit is powered ON. Make sure that nothing is obstructing the transmit and receive lens. Make sure the unit is held steady while pressing  . Make sure that you press-and hold  as long as the laser is active (10 second maximum). Make sure that Filter (Flt) Target Mode is OFF if not using a reflector.
The TruPulse does not have an OFF button.	Simultaneously press-and-hold  and  for 4 seconds. To conserve battery power, the TruPulse turns itself off if no button presses are detected after a specified length of time: <ul style="list-style-type: none"> <li>• TruPulse 360 (or 360B with Bluetooth OFF): 2 minutes</li> <li>• TruPulse 360B with Bluetooth ON: 30 minutes</li> </ul>
Incorrect measurements.	Align the Tilt Sensor ( <a href="#">page 21</a> ). If problem persists, contact LTI for assistance. See inside front cover for LTI contact information.
My Missing Line (ML) results are off (or not within spec).	When performing the ML Routine, do not use handheld. For most accurate results, the TruPulse should be mounted on a tripod or monopod, and use "good practice" ( <a href="#">page 38</a> ).
To improve the accuracy of Missing Line Results:	When aiming to point #2, ensure that the TruPulse is kept perpendicular to a specific point on the ground, and do not use a rapid swinging motion to position the TruPulse. <ul style="list-style-type: none"> <li>▪ Mount the TruPulse on a monopod or tripod.</li> <li>▪ If using TruPulse handheld, <a href="#">see page 38</a>.</li> </ul>

During the Missing Line Routine, AZ calculations are not correct.

Considerations:

- If the 1st shot is taken North of the 2nd shot, the AZ value is calculated correctly. So taking the 1st shot in Quadrant 1, the 2nd shot in quadrant 2, the AZ value is correct. The same thing for the 1st shot in quadrant 4, the 2nd shot in quadrant 3.
- Performing the ML from East to West or West to East, the AZ is calculated correctly.
- When taking a ML from South to North and the North (2nd shot) has a shorter distance range than the South (1st shot), the AZ calculations are incorrect. The HD, SD, INC & VD are all correct. This is from quadrants 2 to 1 and from 3 to 4. If the 2nd shots distance is longer or the same from the 1st shots, the AZ calculation is correct.
- If the AZ value must be known from the South to the North, one should perform the ML function North to South and then apply 180 degrees to the AZ results.

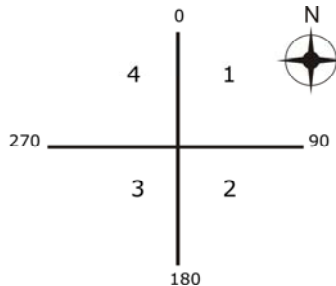

Figure #28

FAiL2, FAiL3, or FAiL4 results during user calibration.

Move to a more suitable location, remove metallic or electronic objects from your person, and retry the Tilt Sensor or Horizontal Angle Compass Calibration Routine.

E37 (or similar value) appears in the Main Display.

Contact LTI Service. See inside front cover for LTI contact information.



## Section 12 – Main Display LCD Characters

The LCD Main Display is used to convey messages and measurement results. When all of the indicators are active the Main Display looks like:



Numbers 0-9:



Alpha Characters:

A = a	G = g	P = p
b = b	H = h	r = r
C = c	, = i	S = s
d = d	L = l	t = t
E = e	n = n	U = u
F = f	o = o	Y = y

Due to the limited number of characters available, many messages have to be abbreviated. The table below lists the messages that appear in the Main Display.

Message	Explanation	Page #
Ang_1	Angle 1. Height Routine.	35
Ang_2	Angle 2. Height Routine.	35
bt	Bluetooth option.	19
btOFF	Bluetooth option off.	19
bt_on	Bluetooth option on.	19
C1_Fd	Calibration point #1 facing forward Tilt Sensor Calibration Routine.	22
	Calibration point #1 facing forward Horizontal Angle Compass Calibration Routine.	30
C2_dn	Calibration point #2 facing down Tilt Sensor Calibration Routine.	22
	Calibration point #2 facing down Horizontal Angle Compass Calibration Routine.	30

Message	Explanation	Page #
[3_bc	Calibration point #3 facing back Tilt Sensor Calibration Routine.	22
	Calibration point #3 facing back Horizontal Angle Compass Calibration Routine.	30
[4_wP	Calibration point #4 facing up Tilt Sensor Calibration Routine.	22
	Calibration point #4 facing up Horizontal Angle Compass Calibration Routine.	30
[5_rf	Calibration point #5 rotated facing forward Tilt Sensor Calibration Routine.	22
	Calibration point #5 rotated facing forward Horizontal Angle Compass Calibration Routine.	30
[6_rd	Calibration point #6 rotated facing down Tilt Sensor Calibration Routine.	22
	Calibration point #6 rotated facing down Horizontal Angle Compass Calibration Routine.	30
[7_rb	Calibration point #7 rotated facing back Tilt Sensor Calibration Routine.	22
	Calibration point #7 rotated facing back Horizontal Angle Compass Calibration Routine.	30
[8_ru	Calibration point #8 rotated facing up Tilt Sensor Calibration Routine.	22
	Calibration point #8 rotated facing up Horizontal Angle Compass Calibration Routine.	30
[CAL	Calibration – Tilt Sensor Calibration Menu	22
	Calibration –Horizontal Angle Compass Calibration Menu	30
:[Cl:]	Closest target mode.	39
:[Con:]	Continuous target mode.	39
d----	Declination value set. AZ only.	34
dECLn	Declination.	24
FR, LI	Fail reason #1 Tilt Sensor Calibration Routine.	23
	Fail reason #1 Horizontal Angle Compass Calibration Routine.	31

Message	Explanation	Page #
FA, L2	Fail reason #2 Tilt Sensor Calibration Routine.	23
	Fail reason #2 Horizontal Angle Compass Calibration Routine.	31
FA, L3	Fail reason #3 Tilt Sensor Calibration Routine.	23
	Fail reason #3 Horizontal Angle Compass Calibration Routine.	31
FA, L4	Fail reason #4 Tilt Sensor Calibration Routine.	23
	Fail reason #4 Horizontal Angle Compass Calibration Routine.	31
FA, L6	Fail reason #6 Tilt Sensor Calibration Routine.	23
	Fail reason #6 Horizontal Angle Compass Calibration Routine.	31
∴FAr∴	Farthest target mode.	39
∴FLt∴	Filter target mode.	39
H_Ang	Horizontal Angle.	24
HARAL	Horizontal Angle Compass Calibration.	24
inc	Inclination.	21
no	No.	22 & 30
PASS	Pass Tilt Sensor Calibration Routine.	23
	Pass Horizontal Angle Compass Calibration Routine.	31
Shot 1	Shot 1 Missing Line Routine.	37
Shot 2	Shot 2 Missing Line Routine.	37
∴Std∴	Standard target mode.	39
Units	Units.	18
YES	Yes.	22 & 30

